

General Specifications

- Display 1.2" LED display or 25mm LCD display with LED backlight
- Capacities 600kg~10t
- Keyboard 4 keys (Mechanical switch)
- Housing Die-cast aluminum
- Max. Divisions 6,000d
- ADC Sigma delta
- ADC update $\leq 1/10$ second
- Operating Temp. $-10^{\circ}\text{C} \sim +40^{\circ}\text{C}$
- Power AC adapter (12V/500mA), Internal rechargeable battery (lead acid 6V/10Ah)



- Programmable to meet customer needs
- Applications: 1. Tare 2. Hold 3. Weighing unit conversion
- SGS 300% safety approval
- Battery provides up to 60 hours of continuous use (without backlight)
- Optional hand held remote control device



TM Crane Scales

Model Name	Capacity	Readability	Division	Approx. weight	Approval
TM-600kg	600kg	0.1kg	6,000d	14kg	CE, GS
TM-1t	1t	0.2kg	5,000d	14kg	CE, GS
TM-2t	2t	0.5kg	4,000d	16kg	CE, GS
TM-3t	3t	0.5kg	6,000d	18kg	CE, GS
TM-5t	5t	1kg	5,000d	22.5kg	CE, GS
TM-10t	10t	2kg	5,000d	35kg	CE, GS

Options



Dimensions(mm)

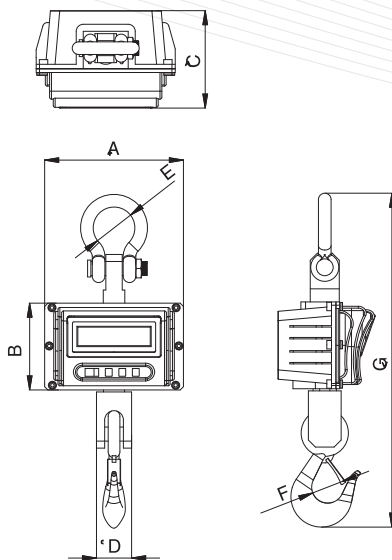

	A	B	C	D	E	F	G
1t	270	173	192	50	68	51	582
2t	270	173	192	50	68	51	582
3t	270	173	192	60	74	63.5	680
5t	297	185	233	75	74	63.5	715
10t	297	185	233	93	92	76.2	815